



smart CONTROL

The assistance system for the injection moulding production

EWIKON



smart CONTROL

Complete process monitoring – the digital future for your mould

Ensuring high efficiency, process reliability and part quality is an essential requirement in modern injection moulding applications. The smart CONTROL assistance system records, monitors, analyses and logs the data of the entire injection moulding production cell and also integrates the hot runner system and the related control technology into the networked injection moulding process. This enables:

- Transparent, efficient and safe processes
- Simplified process optimisation by data analysis and live simulation
- Quality monitoring and management

With its innovative features, smart CONTROL thus makes an indispensable contribution to digitalisation in injection moulding production.



smart CONTROL is available as:

- Integral component of new EWIKON hot halves or Drop-In systems
- Compact unit for mounting directly on the injection moulding machine

smart CONTROL features at a glance

- +** **Permanent collection and logging of all relevant process data**
related to the injection moulding production cell including the hot runner system
- +** **Assistance functions for optimum process transparency**
Easy data analysis with status visualisation
- +** **Completely integrateable into the networked injection moulding production**
Communication with machine, hot runner, peripherals and higher-level software systems via OPC UA and REST API
- +** **Unique *virtual RHEOLOGY* function for the hot runner system**
Live simulation of the melt flow with real-time calculation of shear rates and residence time
- +** **Comfortable data access and permanent data backup**
Browser-based user interface for user-friendly visualisation of data. Worldwide availability. Secure access via mobile devices without additional software installation
- +** **Easy integration into company networks via Ethernet interface**
- +** **Simplified service by remote diagnosis**



Completely integrated into the networked injection moulding production

Via the OPC UA communication protocol, smart CONTROL can communicate with all components of the injection moulding production cell, with EWIKON peripheral devices such as hot runner controllers or the control technology for electric valve gate servo drives as well as with other OPC UA-capable machines and devices. Integration into other systems or software applications, such as production control systems, is also easily possible via OPC UA or the REST API interface.

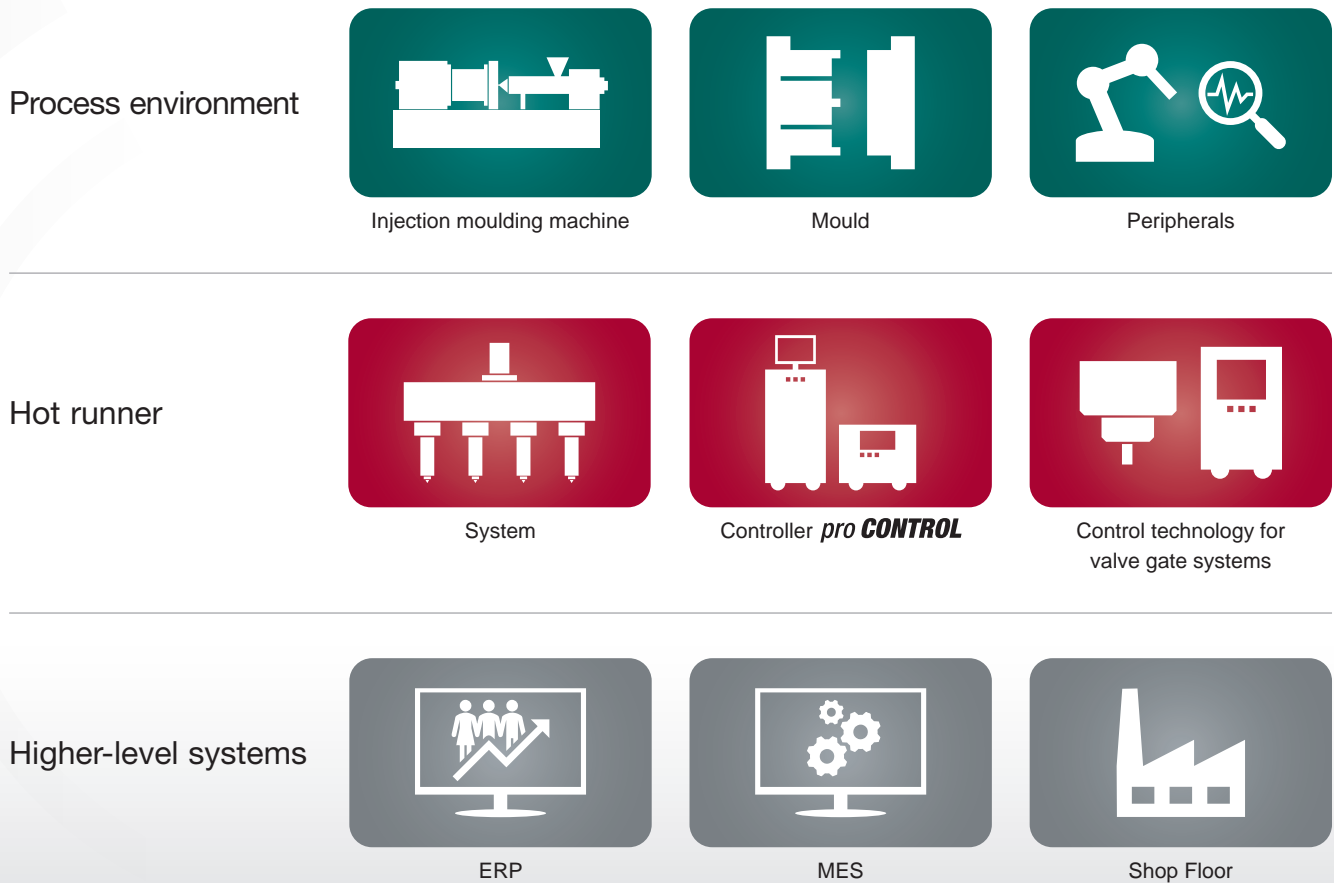

This data is collected by smart CONTROL

■ Injection moulding machine / mould / peripherals / higher-level systems

Injection moulding process parameters, signals from the injection moulding machine (analogue / digital), mould temperatures, data from temperature and pressure sensors, data from other peripheral devices, data from MES and ERP systems

■ Hot runner system and hot runner controller

Temperature values and power data of all heating zones, hot half plate temperatures, shear rates and residence time, valve pin positions and drive temperatures (hydraulic / pneumatic drives), status of the controller / error messages

■ Valve gate control technology for electric drives

Valve pin speeds and positions, required torques, drive temperatures, status of the controller / error messages

Clear visualisation

- Clear display and evaluation of all recorded data of the hot runner system, the injection moulding machine, the mould and other peripheral devices
- The dashboard with integrated productivity display and the most important temperature data of the system components provides information on the current system performance at a glance. Detailed information can be called up at further levels
- All collected data can be evaluated cycle- or time-dependent and conveniently compared with each other
- Integrated assistance function with status visualisation for process evaluation based on defined limit values. If these are exceeded, freely selectable follow-up actions can be triggered, for example alarms or warning messages by e-mail to a specific distribution group

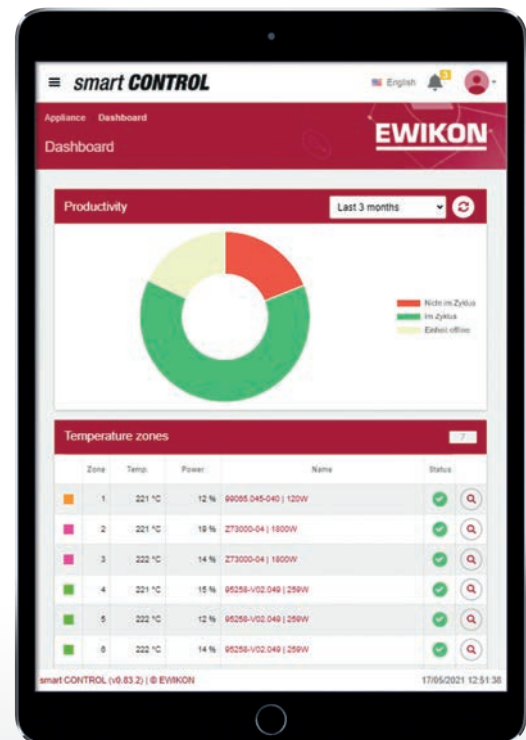

Browser-based user interface and virtual assistance

Optimise system operation – eliminate error sources

- Virtual assistance for the machine operator
- Instructions for effective use of the hot runner system, for example for mould set-up, optimal operation of valve gate systems and for the colour change process
- Troubleshooting and recommended solutions when moulded part defects occur

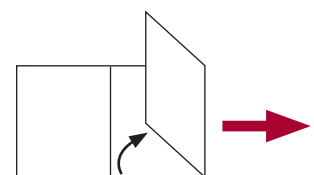
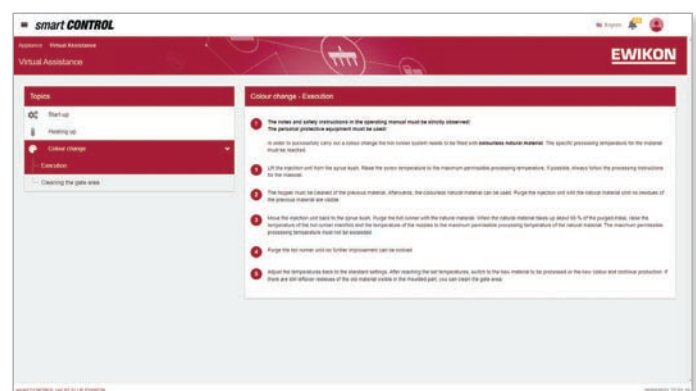

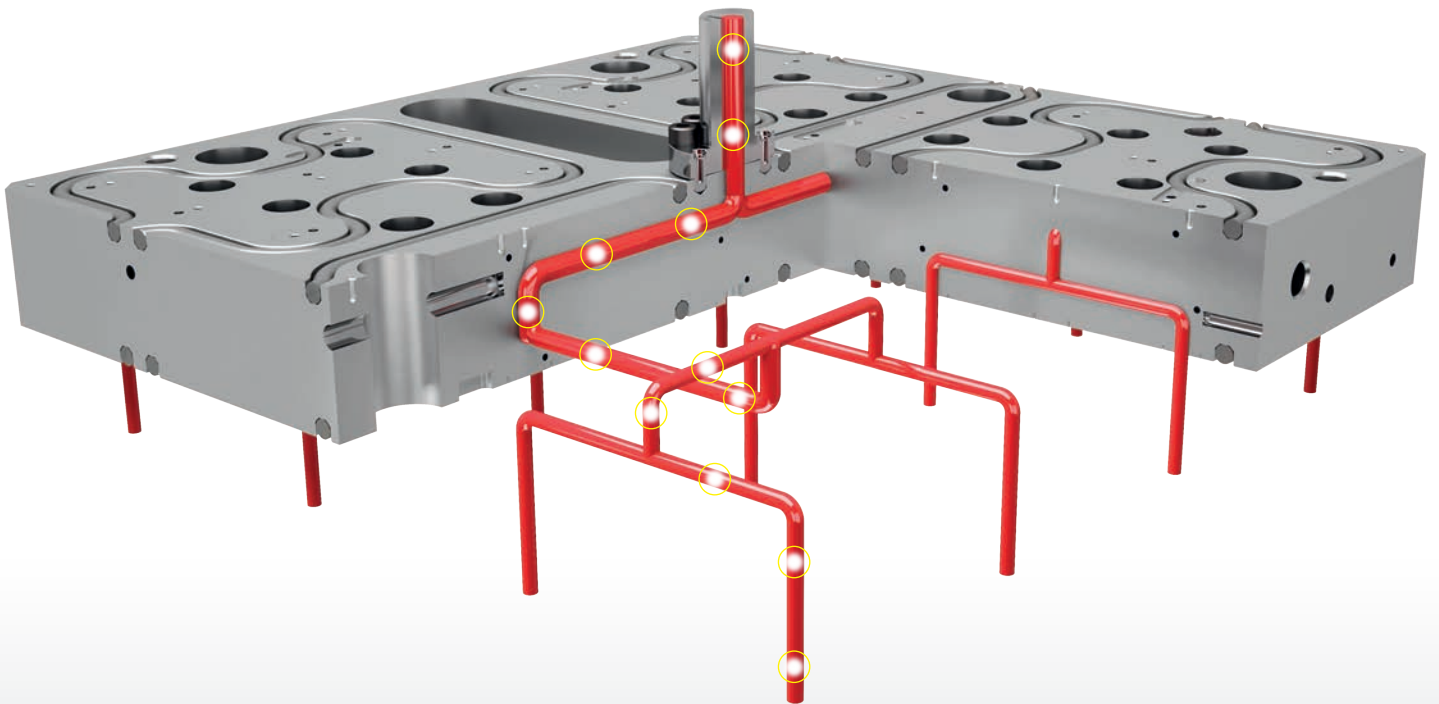

virtual RHEOLOGY – the melt flow becomes transparent

Option Integrated live simulation in real time based on current process data

- Live monitoring of shear rates and residence time in the hot runner system for optimum part quality
- Possibility of targeted process optimisation when processing shear-sensitive or residence time-critical materials
- Facilitation of colour changes by setting the optimum shear rate in the entire system
- Calculation of the shear rates at various positions in the hot runner system, such as manifold, hot runner nozzles or gate, based on the material and geometry data stored in the system and the hot runner temperatures and injection parameters of the injection moulding machine recorded for the current shot
- Graphical display of results. It can be seen at a glance whether adjustments to injection moulding parameters (e.g. temperatures or injection speed) run the risk of exceeding or falling below critical shear values and thus impairing the quality of the parts produced

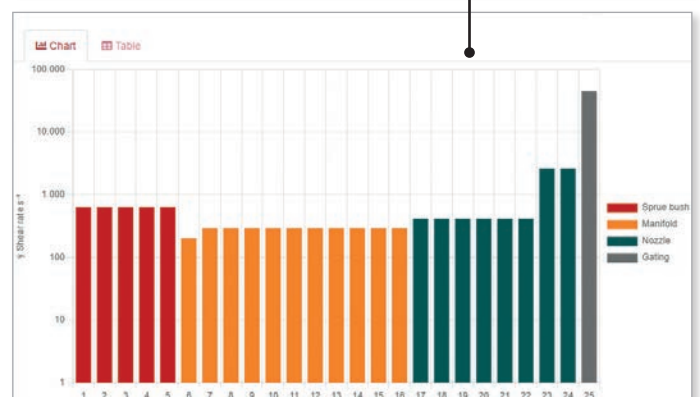
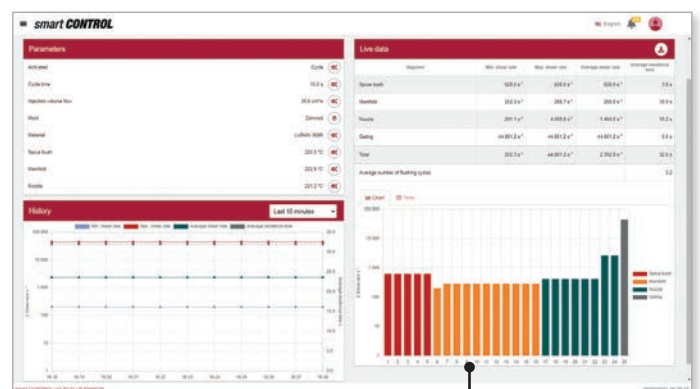

Diagram of shear rates in the system



smart CONTROL Mould package

- The smart hot runner mould: smart CONTROL as an integral part of a hot half or a Drop-In system (integrated in the wiring box). Monitoring of the injection moulding process over the entire life cycle of the mould
- When using virtual RHEOLOGY, all material and geometry data are already stored
- Collection of hot runner temperatures and plate temperatures of the hot half possible via analogue temperature inputs

Versions



smart CONTROL Machine package

- Flexible use in injection moulding production cells
- Supplied as compact unit for mounting directly on the injection moulding machine
- Monitoring of different moulds possible
- For the collection of hot runner temperature and power data, the control technology used must be OPC UA-capable
- When using virtual RHEOLOGY, the material and geometry data for each mould must be uploaded separately

| | Standard features | Extensions (packages) |
|--|-------------------|-----------------------|
| Software: Number of parallel collectable data* | 20 | +10 |
| Ethernet interface  | 2** | |
| Digital inputs | 4 | +8 |
| Digital outputs | 2 | +8 |
| Analogue inputs | 1 | +4 |
| Analogue temperature inputs | 6*** | +6 |
| virtual RHEOLOGY | | ● |

* Data via OPC UA and digital and analogue interfaces. All data of a hot runner control zone (e.g. temperature and power) count as one data element. Any number of collectable data elements can be created, but only the booked number can be recorded

** Plus an Ethernet interface for the integration of smart CONTROL into a network

*** Only with *Mould package*

Features and connectivity options

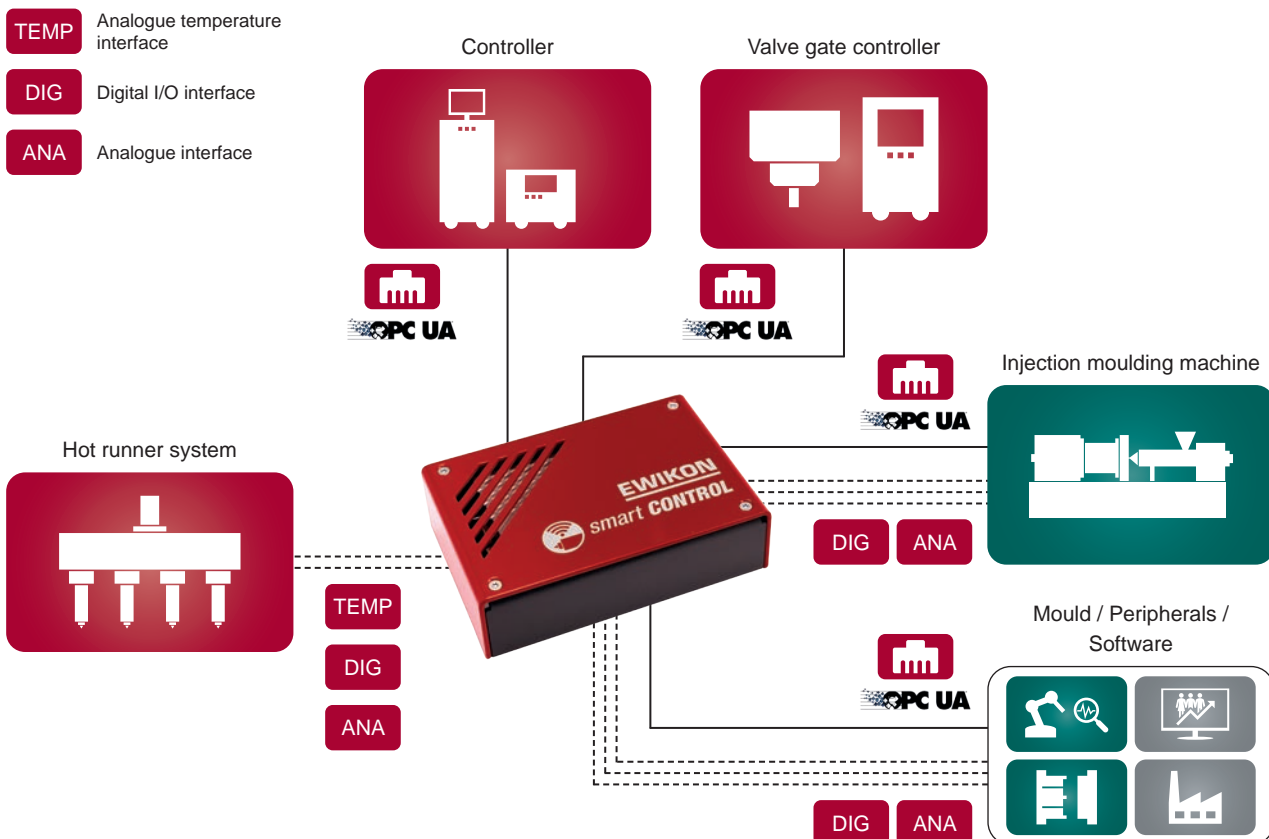

EWIKON
Heißkanalsysteme GmbH
Siegener Straße 35
35066 Frankenberg / Germany
Tel: +49 6451 501-0
E-Mail: info@ewikon.com
www.ewikon.com

Your EWIKON partner:

